

Varenummer: 0106041
 Beskrivelse: Seeger låsering JV 24

Mål

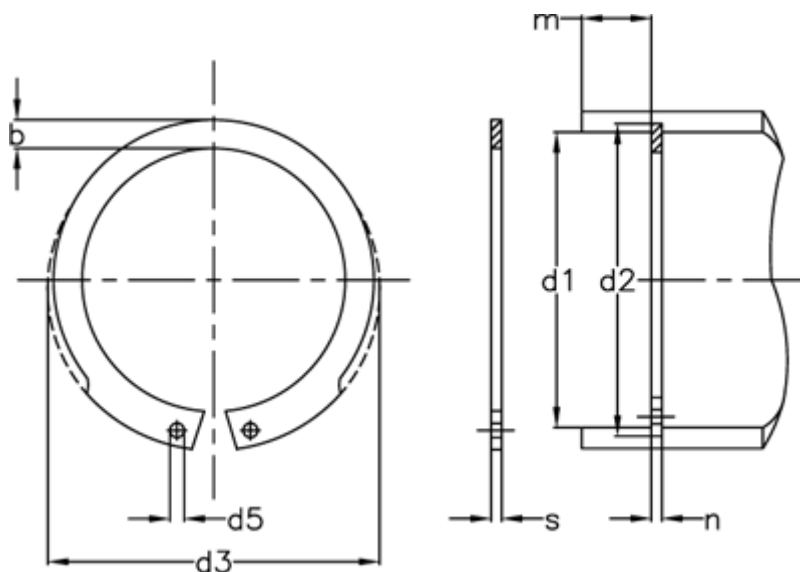

AN mm ²	= 22	FRg kN	= 4.8	Tang	= ZGJ-1
b	= 2.8	FR kN	= 14.5	tol	= -0.06
Betegnelse	= JV 24	g	= 1.0	tol	= +0,42-0,21
d1	= 24	K kN-mm	= 29.9	tol	= +0,21
d2	= 25.2	m min	= 1.30	tol	= 0.1
d3	= 25.9	Nominel træk	= 1.8	vægt kg/1000	= 1.30
d5 min	= 1.5	s	= 1.20		
FN kN	= 3.68	t	= 0.60		